

× pro plech tl. 1,5-3mm

SM-850

EPDM

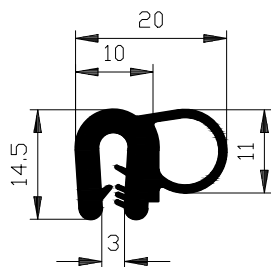

× pro plech tl. 1,5-3mm

SM-861

PVC-EPDM MIKRO

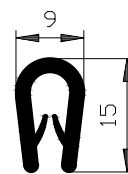

× pro plech tl. 1-3mm

SM-862

PVC

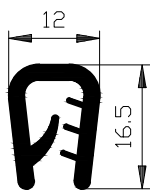

× pro plech tl. 3-5mm

SM-863

PVC

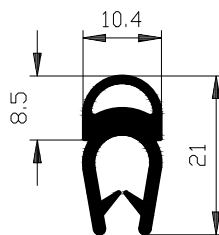

× pro plech tl. 1-4mm

SM-871

PVC/EPDM MIKRO

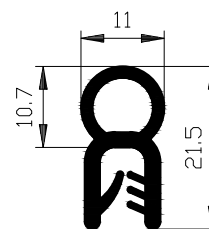

× pro plech tl. 1-3mm

SM-872

EPDM 50



× pro plech tl. 1-2mm

SM-873

PVC/EPDM MIKRO

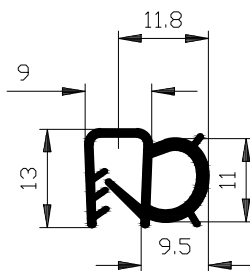

× pro plech tl. 2mm

SM-875

EPDM/EPDM MIKRO

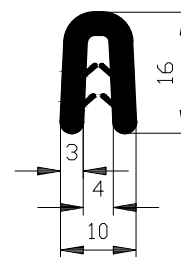

× pro plech tl. 2-3mm

SM-876

EPDM

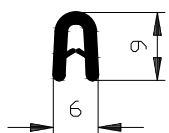

× pro plech tl. 0,5-1,5mm

SM-877

PVC

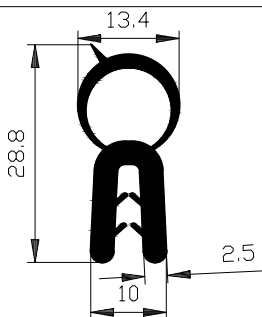

× pro plech tl. 2-4mm

SM-878

EPDM/MIKRO

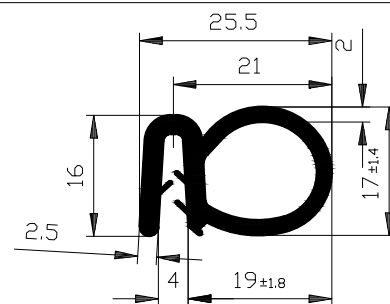

× pro plech tl. 2-3mm

SM-879

EPDM/MIKRO

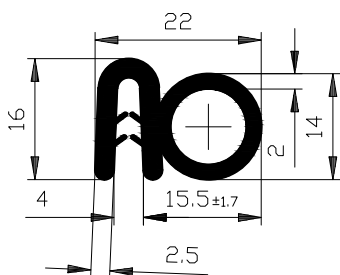

× pro plech tl. 2-3mm

SM-880

EPDM/MIKRO

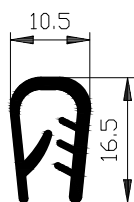

× pro plech tl. 4-6mm

SM-889

PVC